



Thor Coastal Floodlight

150W

Applications:

Residential and Commercial Applications.

- High Lumen Lumileds 3030 LED Chip achieving 130lm/W for 20-50W, 140lm/W for 100-200W and 150lm/W for 500W THOR.
- Integrated IP65 constant current LED Power Supply with built in 3-10kV Surge Protection.
- Dynamic thermal management design maximizing heat dissipation ultimately increase the service life of the luminaire.
- Robust design allows for demanding applications.
- Our Premium Range LED Floods come complete with a 1m installation cable.
- 20 to 500W come complete with a breather gland reducing all forms of condensation that may occur due to harsh climatic conditions.
- Aluminium housing with anti-corrosive powder coating finish.
- 316 Stainless steel screws and bolts with 304 Stainless steel reinforced extended bracket.
- White reflector allowing for maximum light distribution.
- Eco-friendly alternative to HID lamps containing no mercury, lead or other harmful chemicals.
- Instant on LED Light Source.

Product Performance

Wattage	150W
Colour Temperature & Stock Code	6000K F116
Operating Temperature	-30~40°C
Life Span/ LB Rating	L80B20>50000H
IP Rating	IP66
LED Driver Brand	Mean Well
Beam Angle	120°
Impact Protection Grade	IK10
Input Voltage	90V- 300V
Surge Protection	4kV
Power Factor	0.95
CRI	>80
Lumen Output	21 000
Lumen Efficiency	140lm/W
LED Chips	Lumileds 3030
LED Chips Qty	160
Dimmable	Non-Dimmable
Dimmable Range	-
UGR	33
(Dali/Trailing/Leading)	-

Physical Characteristics

Weight (kg)	4,22
Housing Material	Die cast Aluminium
Product Dimensions (mm)	394*394*56
Cable Length	1m
Mounting Option	-
Bracket Material	304 Stainless Steel Bracket
Bolts and Screws	316 Stainless Steel

Luminous Intensity Distribution Diagram

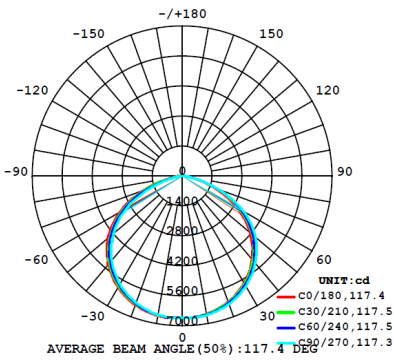

Packaging



Dimension Drawing

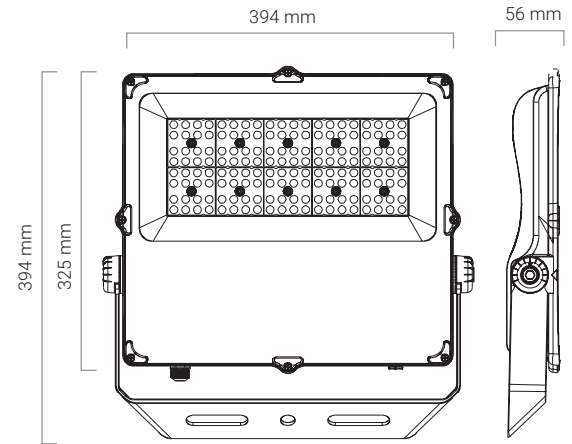

Technical Parameters

Input Current	800mA
Output Voltage	48
Flicker Free (Y/N)	Yes
Humidity	40%~80%
Frequency	47-63hz
In Rush Current	65A
Output Current	2.8A
THD	<20%
TA & TC	TA=-30 ~45 °C/TC=65°C

IES (Yes or No)	Yes
------------------------	-----

Regulatory Qualifications

Class Rating	Class I
Energy Efficiency	A
Certification	CE, EMC, IEC60598, RoHS,ISO9001

Accessories

Optional accessories	Pole Mount Bracket - F025D
-----------------------------	----------------------------

Packaging info

Storage Temp	-40~+60°C
Carton Size (mm)	440*420*115
QTY/CTN	1
Net Weight	4,5
Gross Weight	5,0